

DENSO
DENSO WAVE

2D PRESENTATION SCANNER

QK30
SERIES



SCANS SMARTPHONE DISPLAYS

**SCANS BOTH MOBILE AND
PRINTED QR CODES®**





The QK30-IC has been specially developed for scanning 1D and 2D barcodes on smartphone displays and paper printouts and also has a function for reading IC cards. It is the only scanner in its class to feature programmable, multicoloured LEDs and to play audio files. The compact device is 50% thinner than the previous model, while the scanning surface is 30% larger – ideal for e-ticketing, e-coupons and e-membership cards.

INDUSTRY'S MOST ADVANCED



Optimized performance for both mobile and printed codes

Enables high-speed scanning of 1D and 2D Codes displayed on LCD screens. Excellent scanning performance for codes printed on paper, too.

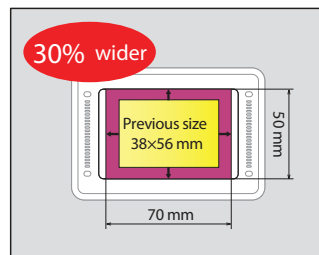

* When scanning codes displayed on an LCD screen

Can scan codes displayed on largescreen smartphones

Scanning area 30% larger than previous model, enabling easier scanning.

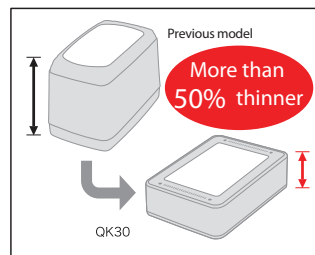

Compact, stylish Design

More than 50% thinner than previous model, increasing placement flexibility.

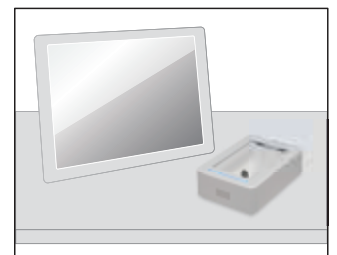

Advanced Features

- ▣ Plays audio files
- ▣ Programmable multicolored LEDs
- ▣ Remote management

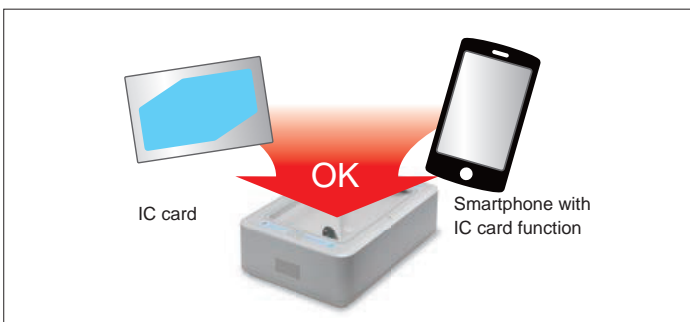

QK30-IC Scans various IC cards

The QK30 Series can scan IC cards (FeliCa*², MIFARE*³ and ISO/IEC14443-Type A/B) and supports NFC Passive Mode.

*1: For QK30-IC(N) and QK31-IC(N) only.

*2: FeliCa is a trademark of Sony Corporation. FeliCa is a contactless IC card system developed by Sony Corporation.

*3: MIFARE is a trademark of NXP Semiconductors N.V.

2D PRESENTATION SCANNER

▣ Scans smartphone displays

▣ Scans both mobile and printed QR Codes® and barcodes

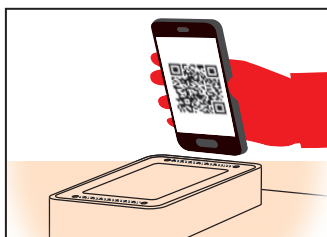

Mobile coupon



Mobile membership card

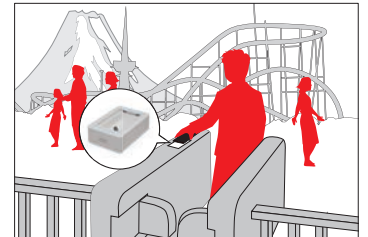

Mobile ticket

Wide range of applications includes use with point-of-sale terminals and incorporation into kiosks and entrance gates. Makes it easy for customers to use mobile coupons, mobile membership cards and mobile tickets.

QK30 SERIES SPECIFICATION

			2D Code model			IC card model	
Type			Stationary type	Built-in type		Stationary type	Built-in type
Model Name			QK30-U	QK31-U	QK31-R	QK30-IC (N)	QK31-IC (N)
Scanner	Readable codes	1D Codes	EAN-13/-8 (JAN-13/-8), UPC-A/-E, UPC/EAN (with add-on), Interleaved 2 of 5 (ITF), Standard 2 of 5 (STF), CODABAR (NW-7), CODE39, CODE93, CODE128, GS1-128 (EAN-128), GS1 DataBar (RSS)				
		2D Codes	QR Code, micro QR Code, SQRC®, iQR Code, PDF417, micro PDF, Data Matrix, Aztec, GS1 DataBar Composite (EAN.UCC Composite), MaxiCode				
	Minimum resolution	1D Codes	0.18 mm				
		2D Codes	0.25 mm				
	Scanning area		70 mm x 50 mm				
	Focusing point		7 mm ¹				
	IC card function	Applicable IC cards	—			FeliCa (Standard/Lite/Plug (NFC Dynamic Tag)), MIFARE (Classic/Ultralight/Ultralight C/DESFire/DESFire EV1), ISO/IEC14443 TypeA/B	
Scan confirmation		LED (blue/red/green),audio	—		LED (blue/red/green),audio	—	
Communication Interface	Method	USB 1.1-compliant (COM, HID) ²			RS-232C	USB1.1 (COM) (for IC cards) USB1.1 (COM/HID) (for 2D Codes/1D Codes)	
	Connector	USB connector: type A (integrated cable)	USB connector: type B (detachable cable)	Mini-DIN connector (with detachable cable)	USB connector type A x 2 (with an integrated cable)	USB connector type B x 2 (with a detachable cable)	
	Cable length	1.5 m	1.4 m (sold separately)	1.5 m (sold separately)	2 m	1.4 m (Sold separately)	
Power	Power	Supply from host device ³					
Environmental requirements	Protection level	IPX2	—		IPX2	—	
	Operating temperature	-5 to 50 °C					
	Operating humidity	10-90% RH (non-condensing/non-freezing)					
Weight	250 g (incl. cable weight)		170 g (excl. cable weight)		300 g (incl. cable weight)	170 g (excl. cable weight)	

1: Height from dustproof plate 2: Two interfaces are supported: USB keyboard and USB-COM. When using USB-COM mode, download USB driver from DENSO WAVE website.
3: Connection may not be possible depending on model of PC or USB hub.

PRODUCT CONFIGURATION

Components

- Scanner
- Operation guide
- Instruction manual

Software (Sold separately)

- USB driver (Active USB-COM port driver)
- Configuration application (Scanner Setting 2D)
- SQRC scanning configuration application (SQRC Setting)
- Keyboard interface application (QR_kbif)
- Library for supporting development of IC card devices for Windows® (for IC card models)

Accessories (Sold separately)

- USB cable for QK31-U (1.4 m)
- RS-232C cable for QK31-R (1.5 m)
- Silicone cover for QK30 (blue)*
- Silicone cover for QK30 (black)*
- Silicone cover for QK30 (clear)*



*Cannot be used for QK31.

Items with this mark are available from the DENSO WAVE website (QBdirect) free of charge.

DIMENSIONS

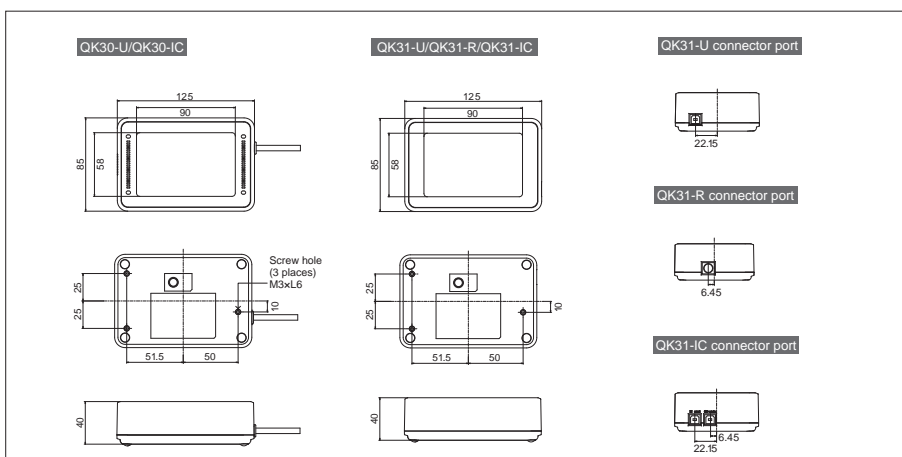

DENSO WAVE EUROPE GmbH

Parsevalstr. 9 A
D-40468 Düsseldorf

☎ +49 211 540 138 40
✉ info@denso-wave.eu

For more information, please visit our website
www.denso-wave.eu